

KanexPro®

EXT-AVIPH264TX USER MANUAL



**H.264 HDMI® Encoder over IP w/ POE &
RS-232**

All Rights Reserved

Version: Ext-AVIPH264TX_2017V1.0

Preface

Read this user manual carefully before using this product. Pictures displayed in this manual are for reference only. Different models and specifications are subject to the actual product.

This manual is only for operational instruction, not for any maintenance usage. The functions described in this version are updated till June 2016. Any changes of functions and parameters since then will be informed separately. Please refer to the dealers for the latest details.

All product function is valid till 2017-6-2.

Trademarks

Product model and logo are trademarks. Any other trademarks mentioned in this manual are acknowledged as the properties of the trademark owner. No part of this publication may be copied or reproduced without the prior written consent.

FCC Statement

This equipment can generate, use, and radiate radio frequency energy and, if not installed and used in accordance with the instructions, may cause harmful interference to radio communications. It has been tested and found to comply with the limits of a Class B digital device, pursuant to part 15 of the FCC Rules. These limits are designed to provide reasonable protection against harmful interference in a commercial installation.

Operation of this equipment in a residential area is likely to cause interference, in which case the user at their own expense will be required to take whatever measures may be necessary to correct the interference

Any changes or modifications not expressly approved by the manufacture would void the user's authority to operate the equipment.



SAFETY PRECAUTIONS

To ensure the best from the product, please read all instructions carefully before using the device. Save this manual for further reference.

- Unpack the equipment carefully and save the original box and packing material for possible future shipment.
- Follow basic safety precautions to reduce the risk of fire, electrical shock and injury to persons.
- Do not dismantle the housing or modify the module. It may result in electrical shock or burn.
- Using supplies or parts not meeting the products' specifications may cause damage, deterioration or malfunction.
- Refer all servicing to qualified service personnel.
- To prevent fire or shock hazard, do not expose the unit to rain or moisture. Do not install this product near water.
- Do not place any heavy items on the extension cable in case of extrusion.
- Do not remove the housing of the device as opening or removing housing may expose you to dangerous voltage or other hazards.
- Install the device in a place with fine ventilation to avoid damage caused by overheating.
- Keep the module away from liquids.
- Spillage into the housing may result in fire, electrical shock, or equipment damage. If an object or liquid falls or spills on to the housing, unplug the module immediately.
- Do not twist/pull by force the ends of the optical cable. It can cause malfunction.
- Do not use liquid or aerosol cleaners to clean this unit. Always unplug the power cord to the device before cleaning.
- Unplug the power cord when left unused for a long period.
- Information on disposal for scrapped devices: Do not burn or mix with general household waste; please treat the devices as normal electrical waste.

Table of Contents

1. Introduction.....	5
1.1 Introduction to EXT-AVIPH264TX.....	5
1.2 Features.....	5
1.3 Package Content.....	6
2. Specifications.....	6
3. Panel Description.....	8
3.1 TX Panel.....	8
3.2 RX Panel.....	8
3.3 Panel Drawing.....	10
4. Installation and Configuration.....	11
5. RS232 and Baud Rate	18
6. Firmware Update.....	18
7. PC Tool Instructions.....	19
8. After-sales Service Warranty.....	26
9. How To Use VLC.....	27
10. Warranty.....	31

Introduction

1.1 Introduction to EXT-AVIP264TX

The KanexPro EXT-AVIPH264TX is an AV over IP Encoder with an HDMI input and Ethernet out which uses advanced H.264 compression algorithm to transmit full HD 1080p from HDMI based sources with less bandwidth over LAN network. It supports PoE (power over Ethernet) with distances over a single CATx up to 394 ft. (120m) delivering one-to-one, one-to-many and many-to-many over the Ethernet switch.

1.2 Features

- Encode and extend pure 1080p resolutions up to 394' / 120 meters
- Features real-time AV coding and decoding to broadcast 1080p
- H.264 Compression technology
- Can be used with DVI connection
- Supports one to many, many to many and point to point broadcasting
- Dual power input: 802.3af compliant w/ POE & DC 5V
- (No need power supply when connecting with POE Switch)
- Can be cascaded to multiple AV over IP Extenders
- Support LPCM audio format
- Smart IP Address Setting: Dynamic Host Configuration Protocol (DHCP)
- Wide-band IR pass through to control the source (38khz to 56khz)
- By pass 2 - way UART/RS232 (Up to 115200), use remote controller to select 8 group Baud rate
- Support one to one, one to many, many to one, many to many modes, with large cascading.

1.3. Packing Content

- 1). 1x Transmitter
- 2). 1x Receiver
- 3). 1x IR-TX cable
- 4). 1x IR-RX cable
- 5). 2X IR Ext Cable
- 6). 1x Manual
- 7). 8x screws
- 8). 4x detachable mounting ears
- 9). 2x Phoenix plugs for RS232 cable termination
- 10). 2x Remote controller

11). 2x Power adapter 5V 1A

2. Specifications

Performance	
Protocol	H.264 encoder over TCP/IP
Support Video format	480i/480p/576i/576p/720p/1080i/1080p@60HZ
Support Audio format	LPCM, Audio sampling rate 48KHZ
Streaming Bit Rate	15Mbps
HDCP	Compliant
IR Frequency	38 -56 KHZ
RS232 Baud rate	Default 2400bps, total 8 options
IP setting &Group ID setting	
Default IP	TX: 192.168.1.11 ; RX: 192.168.1.12
Group ID	Group 00 ~ group 63
Request for Switch/Router	Support IGMP, support DHCP
Connectors on Transmitter	
Input	1xHDMI Female port
Output	1x RJ45 output, 1x HDMI looping output
RS232	Phoenix RS232 port
IR	IR TX port (Support 38K-56KHz) IR Ext port (Support 38KHz)
Connectors on Receiver	
Input	1xRJ45 input
Output	1x HDMI Female port looping output
RS232	Phoenix RS232 port
IR	IR RX port (Support 38K-56KHz) IR Ext port (Support 38KHz)
Environmental & Power Requirements	
Operating temperature	-5 to +35 °C (+23 to +95°F)
Operating Humidity Range	5 to 90%RH (No Condensation)
Power supply	DC 5V 1A
Power consumption	Max 3 watt
Physical	
Dimension	TX:119x79.5x28mm;RX:

	119x79.5x28mm
Net Weight	TX: 0.28KG; RX:0.28KG

Supported input resolution

Frequency	Resolution
50Hz	576i
	576P
	720P
	1080P
	1080i
60Hz/59.94Hz	480i
	480P
	720P
	1080P
30Hz/29.97Hz	1080P
24Hz	1080P
25Hz	1080P

VESA Resolution

Frequency	Resolution
50Hz	576i
	576P
	720P
	1080P
	1080i
60Hz/59.94Hz	480i
	480P
	720P
	1080P
30Hz/29.97Hz	1080P
24Hz	1080P
25Hz	1080P

3. Panel description

3.1 TX

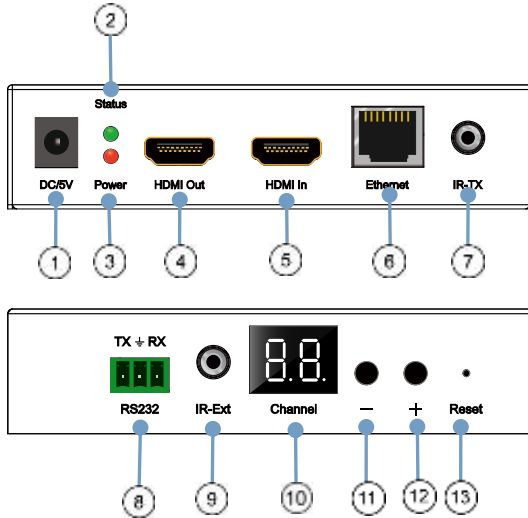

- 1) DC 5V 1A input
- 2) Green indicator of data status ①
- 3) Red indicator of power input ②
- 4) HDMI output for local display
- 5) HDMI input
- 6) CAT5e/6 output
- 7) IR-TX
- 8) RS232 port
- 9) IR-Ext
- 10) LED to show the Group ID
- 11) Press the button for the previous Group ID
- 12) Press the button for the next Group ID
- 13) Reset button



Note ① the green LED will blink once the unit is working.
 ② The LED indicator will glow bright red once the power supply is connected.

3.2 RX

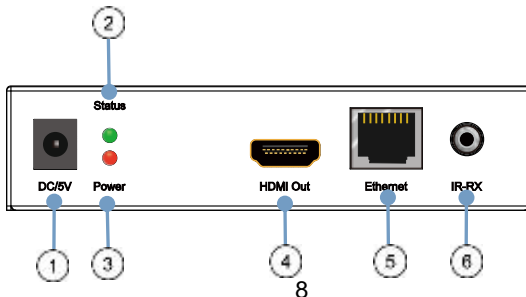

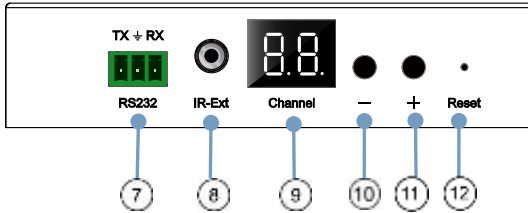

- 1) DC 5V 1A input
- 2) Green indicator of data status ①
- 3) Red indicator of power input ②
- 4) HDMI output
- 5) CAT5e/6 input
- 6) IR-RX
- 7) RS232 port
- 8) IR-Ext
- 9) LED to show the Group ID
- 10) Press the button for the previous Group ID
- 11) Press the button for the next Group ID
- 12) Reset button



Note

- ① The green LED will blink once the unit is working.
- ② The LED indicator will glow bright red once the power supply is connected.

3). How to connect the IR Cable



3.3 Panel Drawing

Transmitter

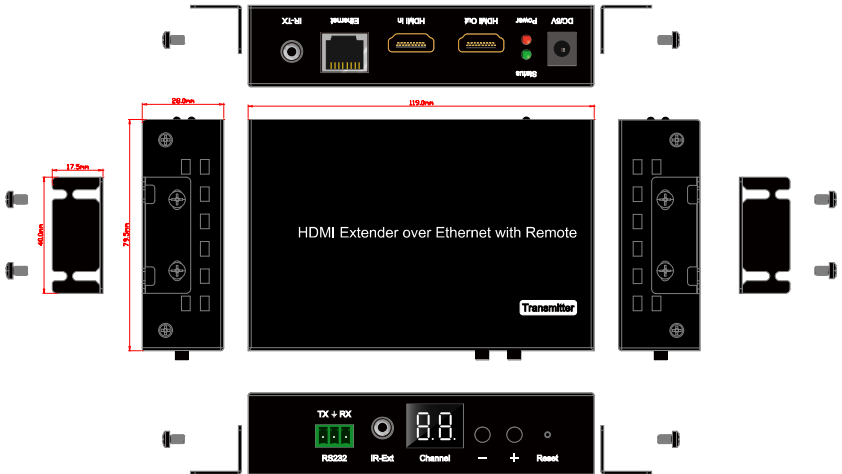

Receiver

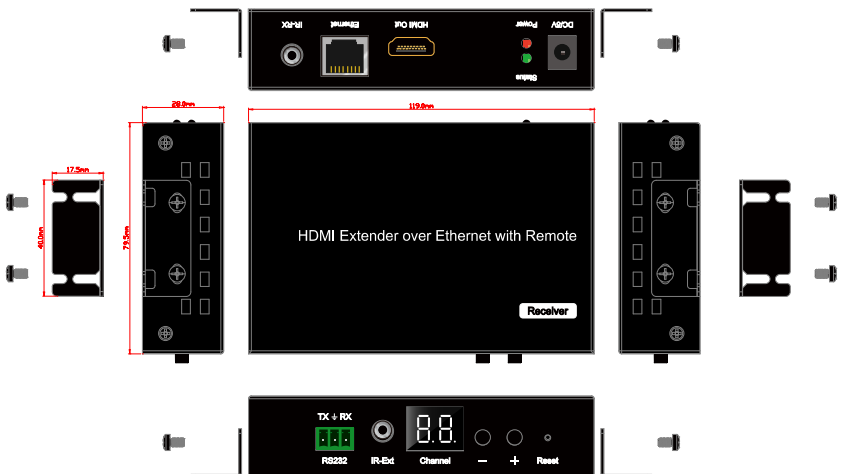

4. Installation and Configuration

Setup HDMI TX and RX

When connecting point to point, no need to configure TX and RX,
When connecting point to many, many to point and many to many, please make sure every TX and RX has unique IP and MAC address, every TX has unique group ID.

AV over IP Extender has been assigned unique default MAC address for every TX and RX, so you don't have to set the MAC for the units.

You just need to set the IP address and Group ID following following steps.

Setting the IP address

A). DHCP (Dynamic host configuration protocol)

If you are using a Switch that supports DHCP, please enable DHCP so that the Switch will assign a unique IP for TX and RX, and you don't need to change the IP for the units manually.

Ethernet:

Use DHCP

Default IP address: 192 . 168 . 1 . 11

Default Netmask: 255 . 255 . 255 . 0

Default Gateway: 192 . 168 . 1 . 1

Subnet

User Setting:

Baud Rate: 115200

Subnet

File to Upgrade Encoder Firmware: [Browse] [Upgrade]

Enable/Reset Reboot LogOut

Use DHCP

Default IP address: 192 . 168 . 1 . 12

Default Netmask: 255 . 255 . 255 . 0

Default Gateway: 192 . 168 . 1 . 1

Update DHCP

Multicast Group: Group 01(239.255.42.43) Port: 5004

Update

User Baud Rate: 115200

Update

Reboot

B). Set the IP via web browser

If you are using a Switch that doesn't support DHCP, please change the default IP for TX (192.168.1.11) and RX (192.168.1.12) manually.

A HTTP server is embedded in each TX and RX. You can set up IP address for HDMI Extender via web browser

The default IP address of the **TX is 192.168.1.11**, user name: admin, password: admin

The default IP address of the RX is **192.168.1.12**

Step 1: Make sure the Transmitter and PC are in the same domain.

Access the Network Setting Control Panel in Windows and locate your Lan connection. Under Windows 7, this can be done by clicking Start > Control Panel > Network Sharing center > Change adapter settings > Properties > Internet Protocol Version4 (TCP/IPv4). Change the IP address field to 192.168.1.1

(0-255). After that press "OK" to save the configuration.



- Note**
- ※The PC and TX/RX should be in the same domain.
 - ※The IP address of PC should be different from the IP address of TX and RX.

Step 2: Use an Ethernet Cable to connect the PC (or laptop) and the extender. the power LED for the extender is red and the green status is blinking.

Step 3: Login in IE: 192.168.1.11 (default IP for TX) or 192.168.1.12(default IP for RX), You can setup IP address for the TX and RX. TX requires user name: admin and password: admin

Please set IP address for each TX and each RX, IP: 192.168.1.XX (XX:1-255. all IP address for TX and RX must be different and can't be same as the PC's address.)

Step 4: After selecting "Use DHCP" or reset the IP Address, click "Submit" (transmitter) or "update DHCP" (Receiver).

Step 5: Click "Reboot".

Use DHCP
 Default IP address: 192 . 168 . 1 . 8
 Default Network: 255 . 255 . 255 . 0
 Default Gateway: 192 . 168 . 1 . 1
 Update DHCP
 Multicast Group: Group (10239.255.42.43) Port: 5004
 Update
 User Band Rate: 115200
 Update
 Reboot

Use DHCP
 Default IP address: 192 . 168 . 1 . 11
 Default Network: 255 . 255 . 255 . 0
 Default Gateway: 192 . 168 . 1 . 1
 Submit
 User Setting
 Band Rate: 115200
 Submit
 File to Upgrade Encoder Firmware: [Browse] [Upgrade]
 Upgrade Band Reboot Logout

Step 6: Restart the extender after resting the IP Address.

Choose the Group ID and Baud Rate by Remote controller

(When the LED shows "00", it's ready to work)

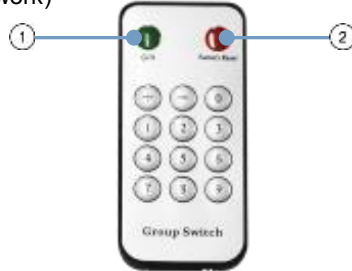

① Press the button, switch to choose the Group ID or Baud rate.

② Factory reset. Press the button for 3 seconds, the LED will flicker then turn to "00", you have successfully finished the factory reset.

Choose Group ID 00-63

- 1). Press "+" or "-" to change to the previous or next Group ID.
- 2). Press the No to change Group ID. For example, if you need change to 01, press "0", then press "1".

Choose the Baud Rate

Press the Button, switch to Baud Rate mode, press "+" or "-" to change the Baud Rate.

F0 = 2400 (default)
 F1 = 4800
 F2 = 9600
 F3 = 19200
 F4 = 28800
 F5 = 38400
 F6 = 57600
 F7 = 115200

3). How to choose the source:

For example, when the connection is:

Source (DVD1) - TX (TX1) - Gigabit Switch – RX (RX1) - TV1

Source (DVD2) - TX (TX2) - Gigabit Switch – RX (RX2) - TV2

Source (DVD3) - TX (TX3) - Gigabit Switch – RX (RX3) - TV3

The group ID of transmitters is:

TX1 (01)

TX2 (02)

TX3 (03)

If you need display Source on TV1, then just set Group ID of RX1 same as TX1: 01(see below picture).



Set the group ID for TX and RX via web browser

**Step 1: Make sure the Transmitter and PC are in the same domain.
(Refer to 5.1.1)**

Step 2: Use an Ethernet Cable to connect the PC (or laptop) and the Extender. the power LED for the extender is red and the green status LED is blinking.

Step 3: Power on the TX or RX with 5V 1A power supply.

Step 4: Login in IE: 192.168.1.11 (default IP for TX) or 192.168.1.12(default IP for RX), TX requires user name: admin and password: admin.

Step5: Change the group ID at “Stream setting”, “00” means group “00” here **which can be chosen from 00 to 63.**

Multicast Group: Port: 5004

Stream Setting:

Transfer: Multicast
 Multicast IP: Port: 5004



Note ✘ When you change the group ID on both Web browser and Remote controller, the units will follow the latest one.

✘ **If you change the Group ID on web browser, it can't be shown on the LED.**

4.2 Preparing the switch

When doing point to many and many to many, it requires a switch to distribute the sources. We suggest you use the Switch that supports IGMP and DHCP. IGMP feature help to manage the group ID which is related to switch the sources; DHCP allow the switch to assign an IP for TX and RX automatically, please enable DHCP of the switch.

4.3 Connection



Note ✘ **Please don't insert into or pull out HDMI cable when power on.
Please connect cable only when power is off.**

4.3.1 Point to point

1. Connect the source device and the Transmitter unit with HDMI Cable.
2. Connect the HDMI looping output of the Transmitter to the local HDMI display.

3. Connect another HDMI display and the HDMI Receiver unit with HDMI Cable.
 4. Connect the Transmitter and Receiver with Cat5e/6 cable
 5. Connect the IR TX cable into "IR TX" port of the transmitter; Connect the IR RX cable into "IR RX" port of the receiver. Then you can control the source at the RX side with IR.
 6. Connect one RS-232 Cable from the PC or automation system to the RS-232 port on the Transmitter; Connect one RS-232 cable from the Receiver to the RS-232 device to be controlled.
 7. Power on Transmitter and Receiver with adapter 5V 1A.
- NOTE: Insert/Extract cables gently.**

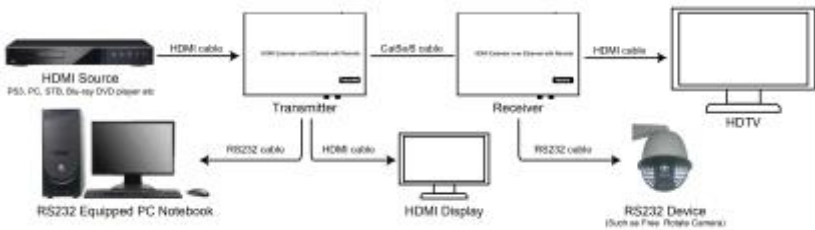

4.3.2 Compatible with Video Player such as VLC etc

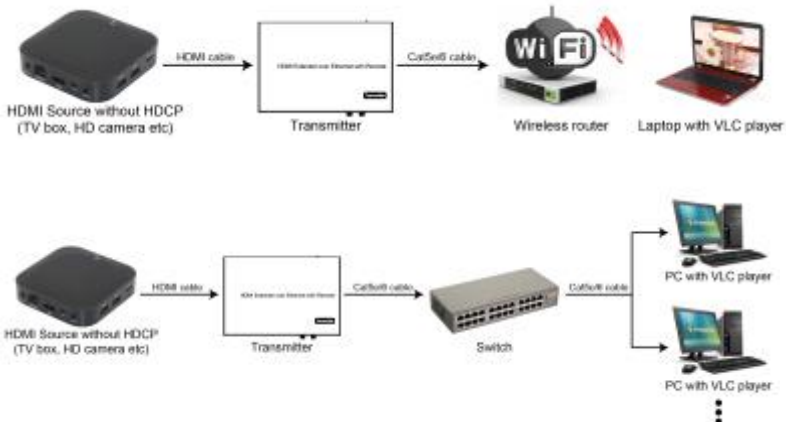

4.3.3 Point to many

1. Setting the IP address for Transmitter & Receiver and preparing the switch following the steps as instructed above (5.1.1&5.2)
2. Connect the source device and the Transmitter unit with HDMI Cable.

3. Connect the HDMI looping output of the Transmitter to the local HDMI Display.
4. Connect the transmitter and the switch/router with cat5e or cat6 cable.
5. Connect all the Receivers and the switch/ router with Cat5e/6 cable.
6. Connect the HDMI displays and the HDMI Receiver units with HDMI Cable.
7. Connect the IR TX cable into “IR TX” port of the transmitter; Connect the IR RX cable into “IR RX” port of the receiver. Then you can control the source at the RX side with IR.
8. Connect one RS-232 Cable from the PC or automation system to the RS-232 port on the Transmitter; Connect one RS-232 cable from the Receiver to the RS-232 device to be controlled.
9. Power on Transmitter and Receiver with adapter 5V1A, power on the switch with its adapter.



Note ※Daisy chain the switch if its RJ45 port is not enough.
 ※The quantity of Receiver is up to 255pcs.

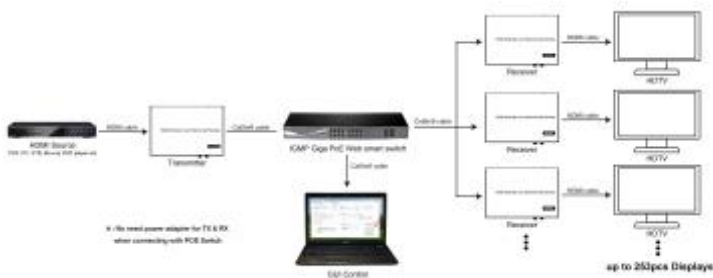

4.3.4 Many to many

1. Setting the IP address for Transmitter & Receiver and preparing the switch following the steps as instructed above (5.1.1&5.2)
2. Connect the source device and the Transmitter unit with HDMI Cable.
3. Connect the HDMI looping output of the Transmitter to the local HDMI Display.
4. Connect the transmitters and the switch/router with cat5e or cat6 cable
5. Connect the Receivers and the switch/ router with Cat5e/6 cable
6. Connect the HDMI displays and the HDMI Receiver units with HDMI Cable.
7. Connect the IR TX cable into “IR TX” port of the transmitter; Connect the IR RX cable into “IR RX” port of the receiver. Then you can control the source at the RX side with IR.
8. Connect one RS-232 Cable from the PC or automation system to the RS-232 port on the Transmitter; Connect one RS-232 cable from the Receiver to the RS-232 device to be controlled.
9. Power on Transmitter and Receiver with adapter 5V1A, power on the switch with its adapter.

10. Choose the source by Remote controller or Web browser as instructed above (5.1.2)



- Note**
- ※Daisy chain the switch if its RJ45 port is not enough.
 - ※The quantity of Transmitter is no more than 64 pcs.
 - ※The total quantity of Transmitter and Receiver is less than 256 pcs.

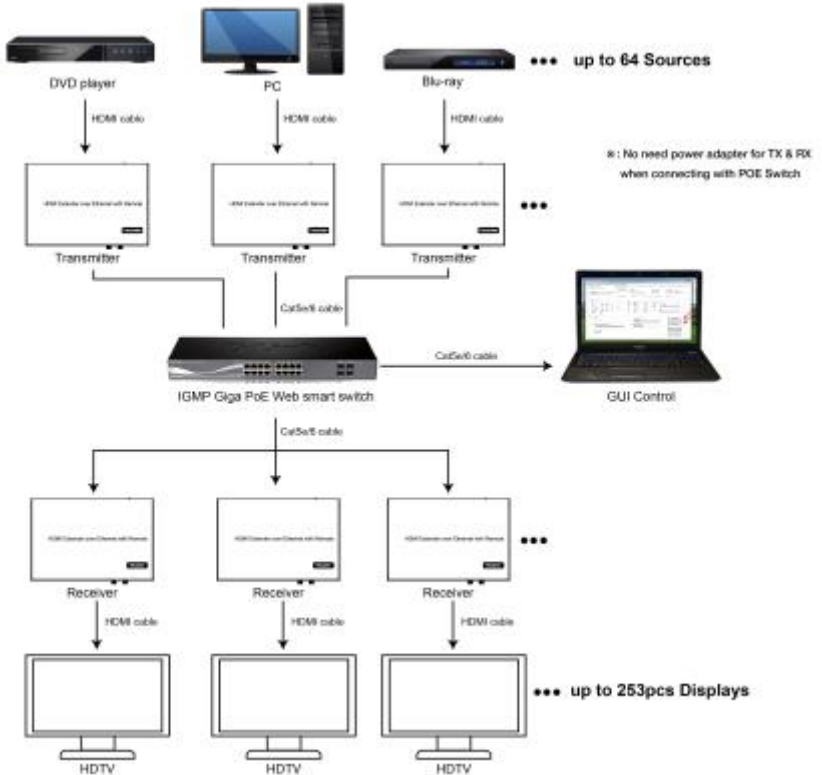

- Note** ※The total qty of TX, RX, Switch is less than 256pcs.

5. RS232 and Baud rate

The unit provides a path to pass through the RS232 signal, RS232 passes

from TX to RX or from RX to TX, connect to your RS232 devices, such as PC, IP Camera, Creston control panel, Smart Matrix, printer and Scanner and so on. It works when TX, RX and your RS232 devices baud rate is the same. The default baud rate of TX and RX is 2400 which is frequently used for most devices.

5.2 Baud rate setting

5.2.1 Setting the Baud rate via Web Browser

Login TX and RX with their default IP (TX: 192.168.1.11; RX: 192.168.1.12) to modify the Baud Rate which range from default 2400 to 115200.

Uart Setting:

Baud Rate: 115200 ▾



Note: When you change the Baud rate on both Web browser and Remote controller, the units will follow the latest one.

※Please send the data in the same group ID.

6. Firmware update

We provide the firmware to upgrade the units when it is necessary. Please follow up following steps to update the firmware.

Step1: Connect TX / RX to the PC with a short Cat5e cable

Step2: Power on TX/ RX with power adapter 5V1A.

Step3: Login TX or RX with their default IP (TX: 192.168.1.11; RX: 192.168.1.12) on web browser, TX requires user name: admin and password: admin

Step4: Click “choose File” on the interface and find out the latest version firmware

Step5: Click “Upgrade”, the process will takes seconds, please DO NOT interrupt or power off the units during the time.

File to Upgrade Firmware:

Choose File No file chosen

Upgrade!

tiny pin to insert

the reset hole and hold about 10 seconds, when the unit is connected.



7. PC Tool Instructions

Step 1: Make sure the Transmitter and PC are in the same domain. (Refer to 5.1.1)

Step 2: Open the PC Tool.



Step 3: Click “Start Scan”.

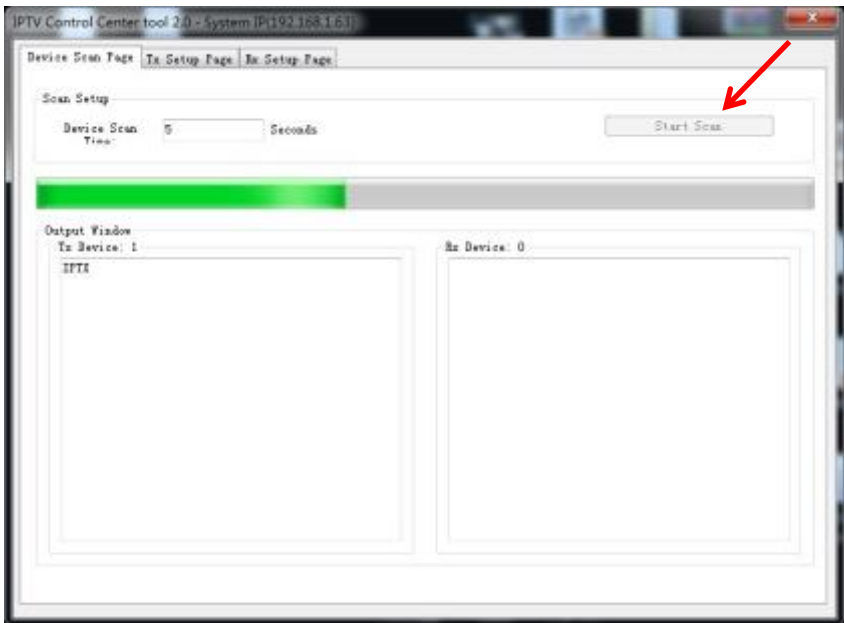

Step 4: Choose the TX or RX Name.

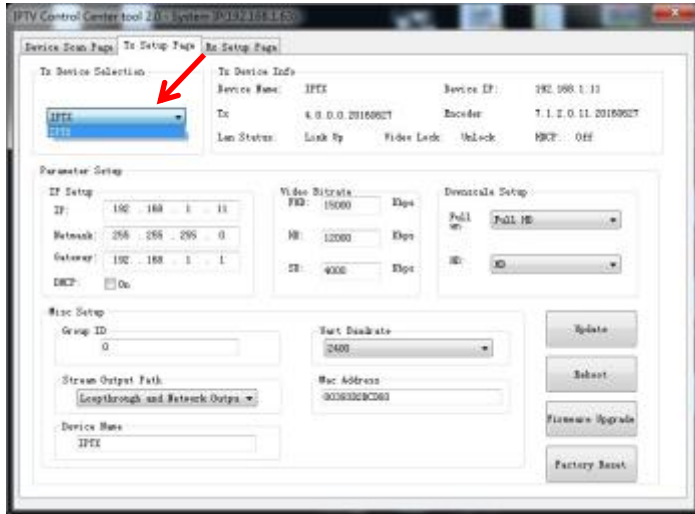

7.1 Firmware Upgrade

Step 1: Click "Firmware Upgrade".

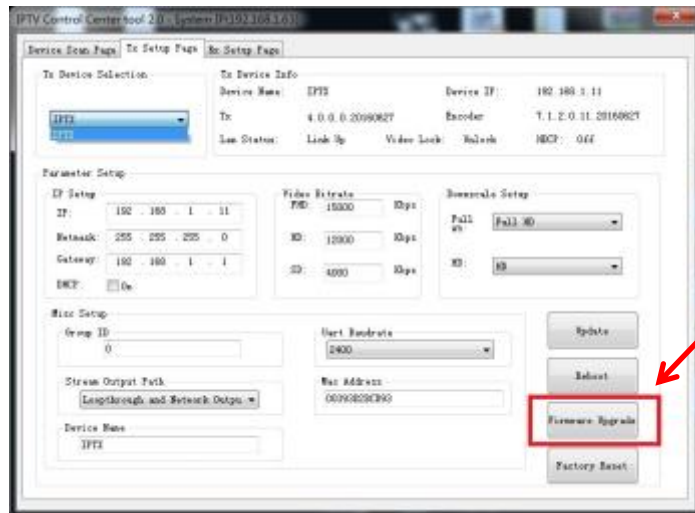

Step 2: Click “Upgrade Encoder FW” first.

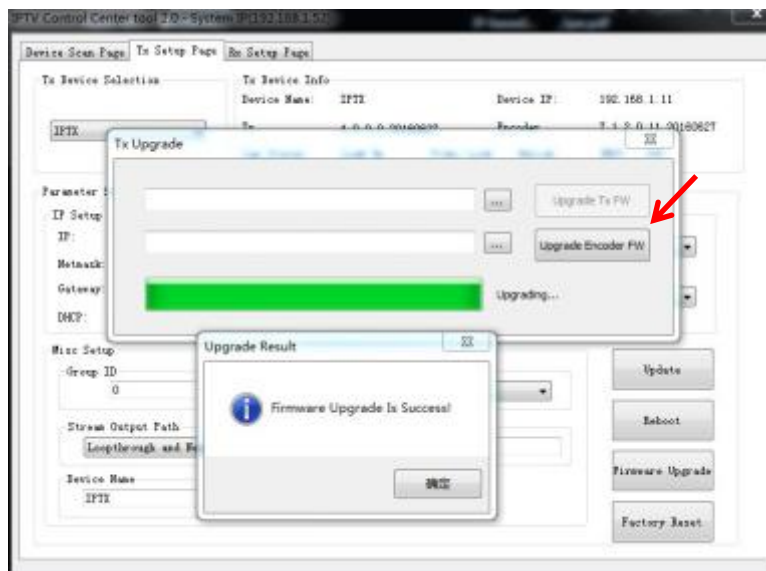
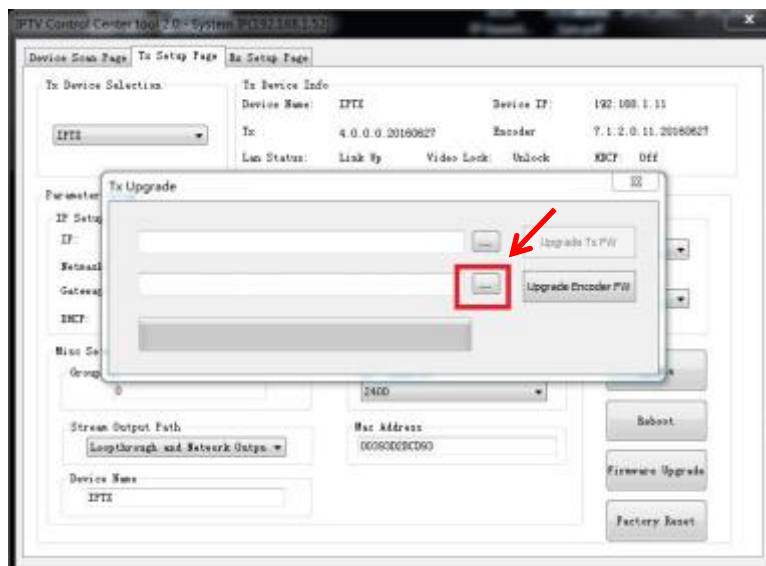

Step 3: After the step 2 is finished, click “Firmware Upgrade” again, then click “Upgrade TX FW”.

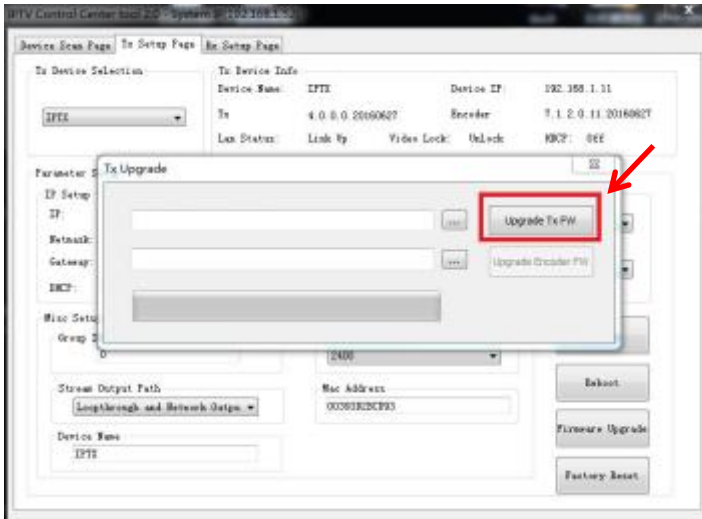

Upgrade for RX

Step 1: Click “Firmware Upgrade”.

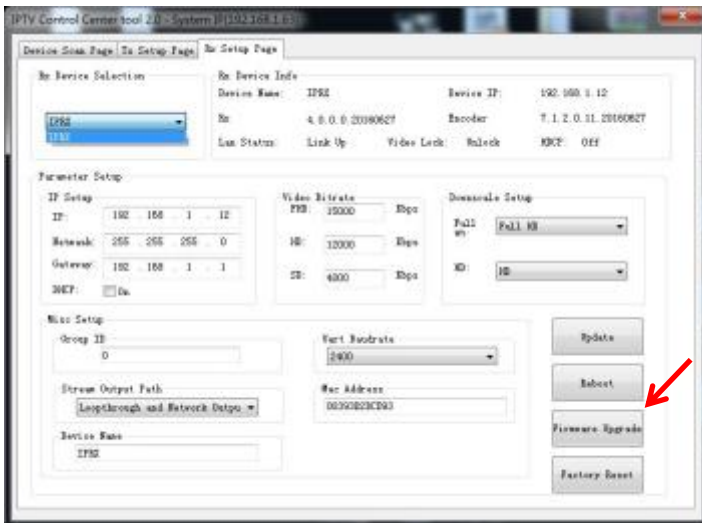

Step 2: Click "Upgrade Rx FW".

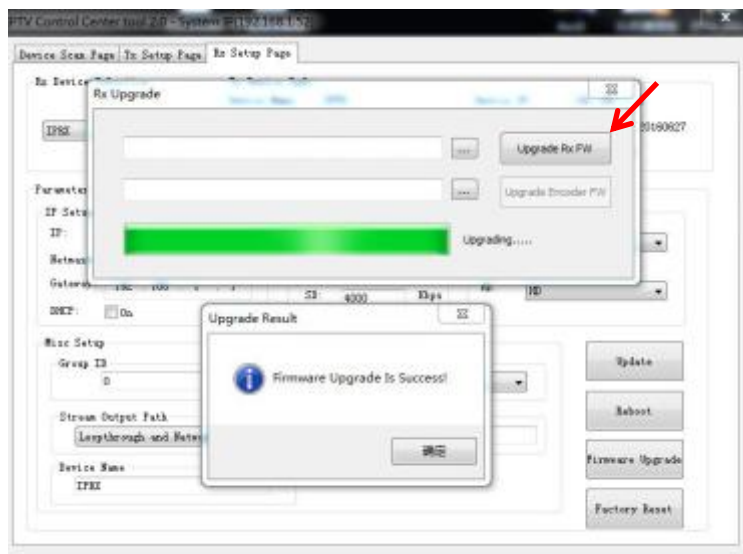
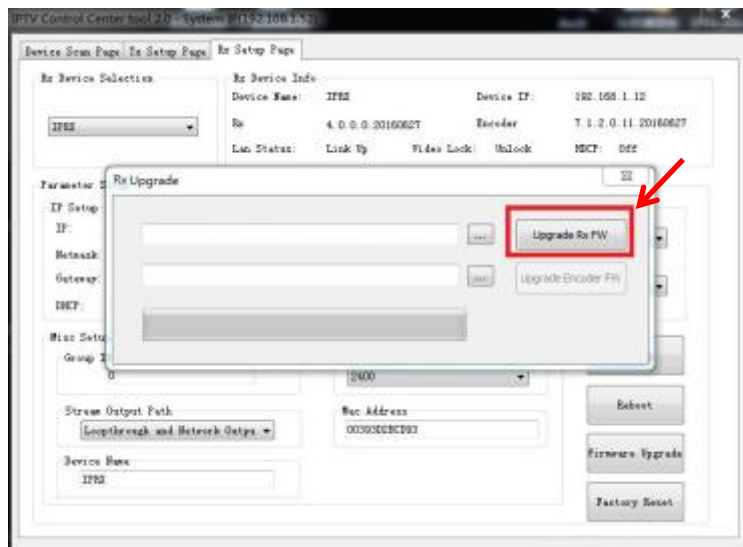

7.2 Other settings

Step 1: Change the IP/Netmask/Gateway/DHCP/Uart Baudrate/Group ID/Mac Address/ Device name on the PC tool interface.

Step 2: Click “Update”, after “Update” is finished, click “Reboot”.

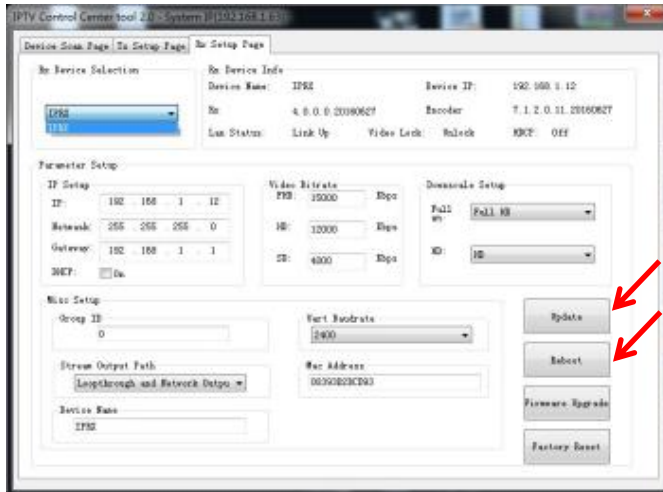
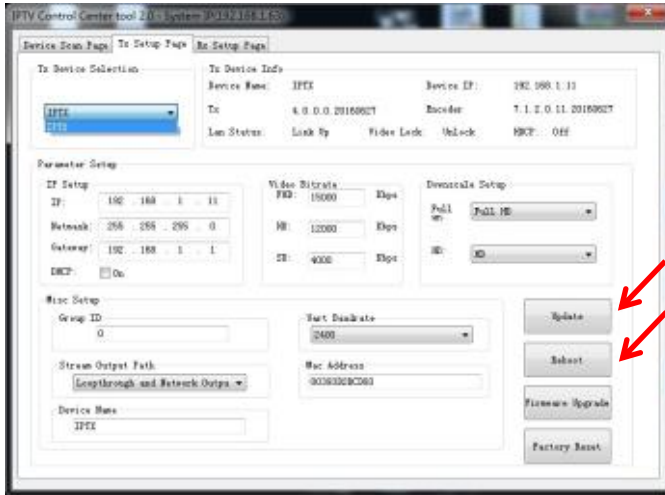

7.2 Click “Factory Reset” on TX or RX.

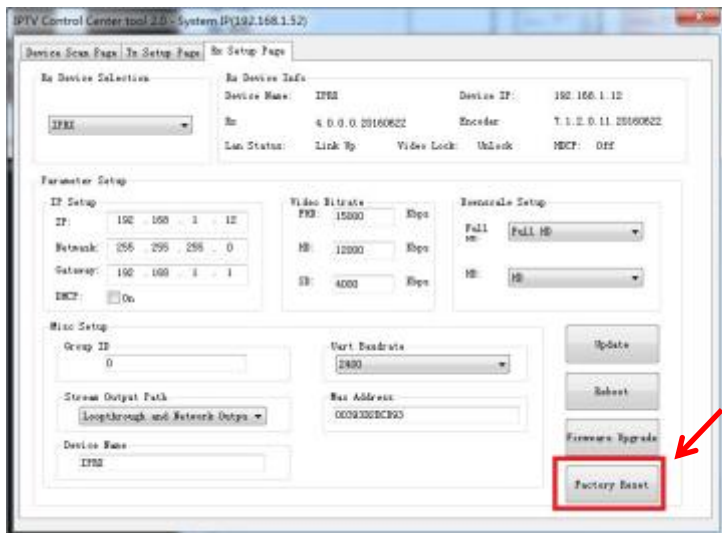
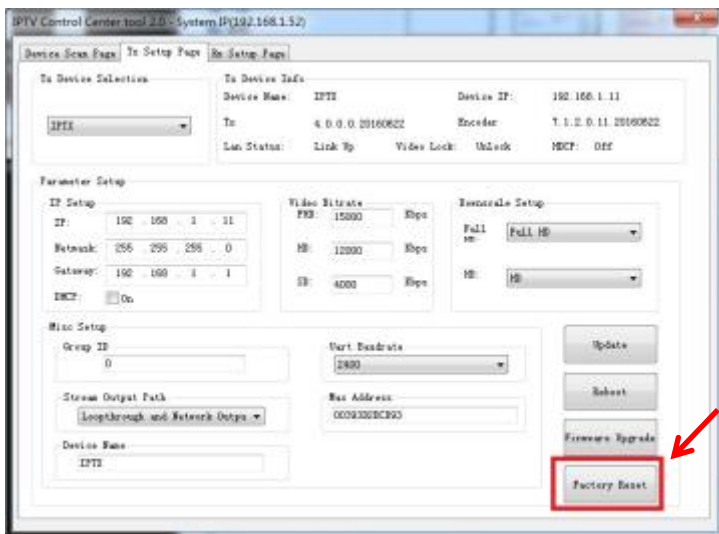

8. After-sales Service and Warranty.

If problems arise when operating the device, please refer to this user manual.

Any transport costs are borne by the users during the warranty.

- 1) Product Limited Warranty:** We warrant that products will be free from defects in materials and workmanship for **two years**, which starts from the first day the product exits warehouse. (Make note of the serial number on the product)

Proof of purchase in the form of a bill of sale or receipted invoice **MUST** be presented to obtain warranty service.

2) What the warranty does not cover:

- Warranty expiration.
- Factory applied serial number has been altered or removed from the product.
- Damage, deterioration or malfunction caused by:
 - Normal wear and tear
 - Use of supplies or parts not meeting our specifications
 - No certificate or invoice as the proof of warranty.
- 1) The product model showed on the warranty card does not match with the model of the product for repairing or had been altered.
 - Damage caused by force majeure.
 - Servicing not authorized
 - Any other causes which does not relate to a product defect
- Delivery, installation or labor charges for installation or setup of the product

- 3) Technical Support:** Email or call our after-sales department if there are any problems or any unanswered questions. Please inform us the following information about your cases:

- Product version and name.
- Detailed failure situations.
- The formation of the cases.

Remarks: For any questions or problems, please try to get help from your local distributor or contact kanexpro.com or call us at 888-975-1368 for further support.

9. How to use VLC

Step1: Make sure the Transmitter and PC are in the same domain.

(Refer to 5.1.1)

Step2: Connect the HDMI Source without HDCP with the transmitter and power on the device.

Step3: Connect the transmitter to the PC.

Step4: Check the Multicast Group on the web (refer to 5.1.3).

Step5: Open the VLC media Player, click “Stream”> “Network”, Input “UDP: //@ 239.255.42.42 :5004”



Note

※239.255.42.42 (Multicast Group) 5004 (Port)

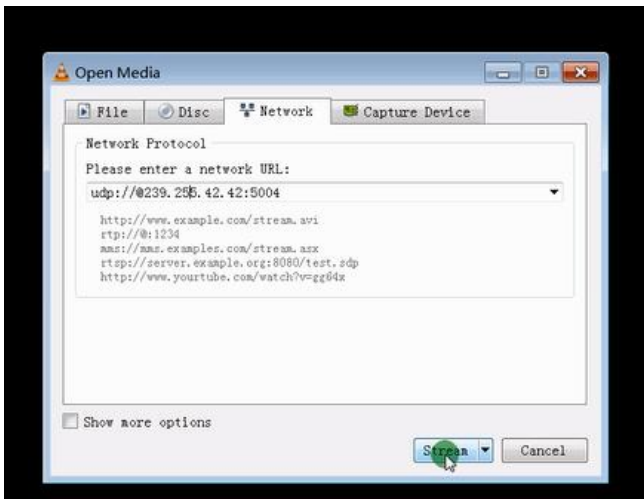
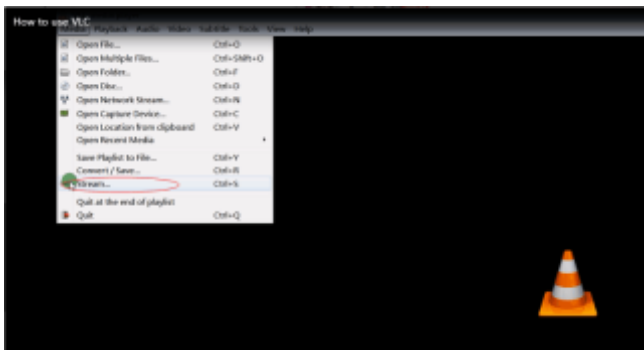

Step 6: Click "Next".

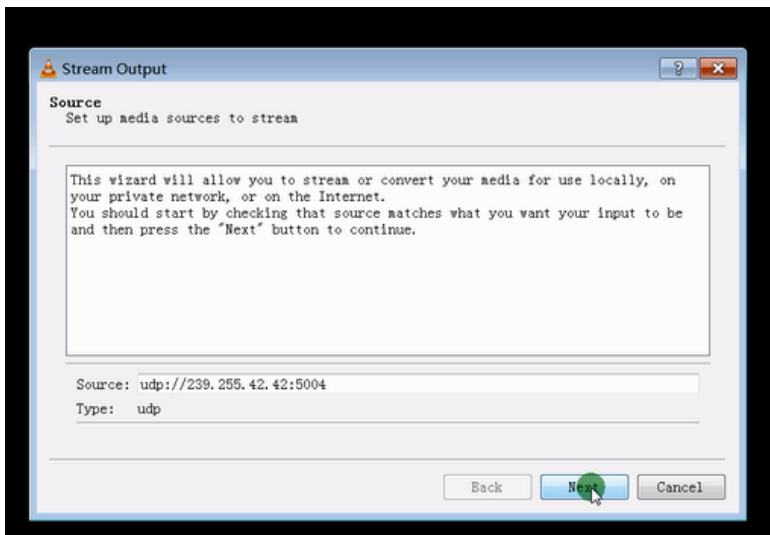

Step 7: Choose "RTP / MPEC Transport Stream" or "UDP".

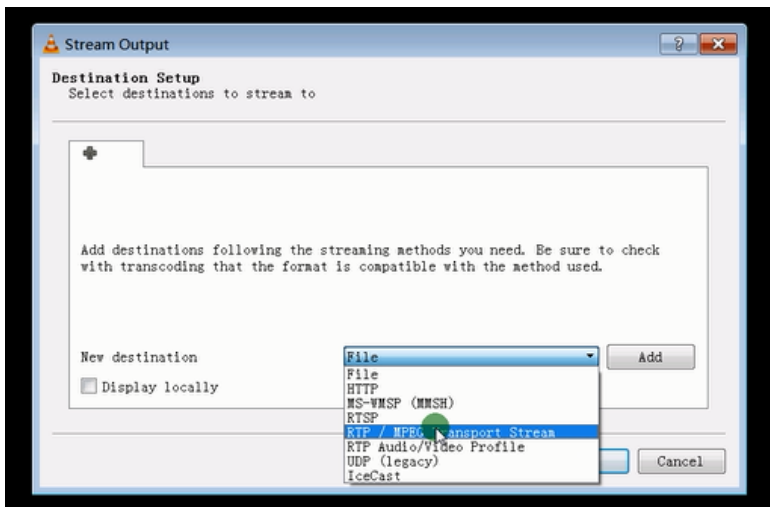

Step 8: Click “Next”.

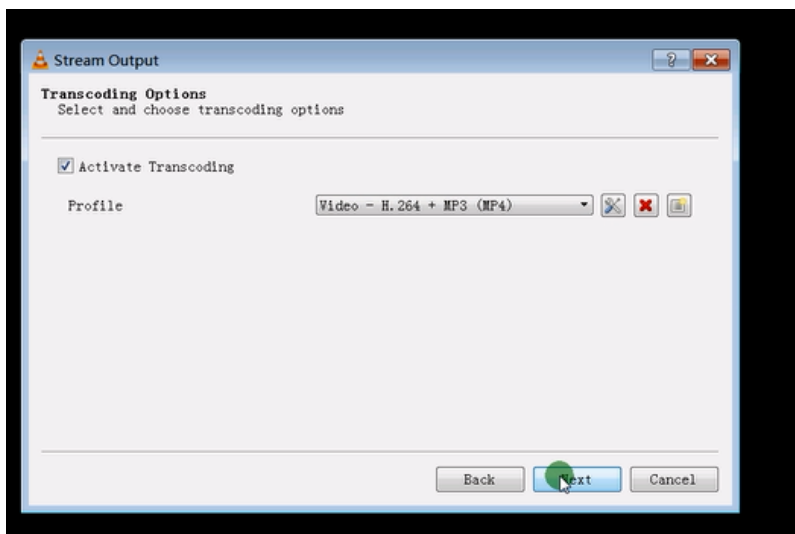

Step 9: Click “Stream”.

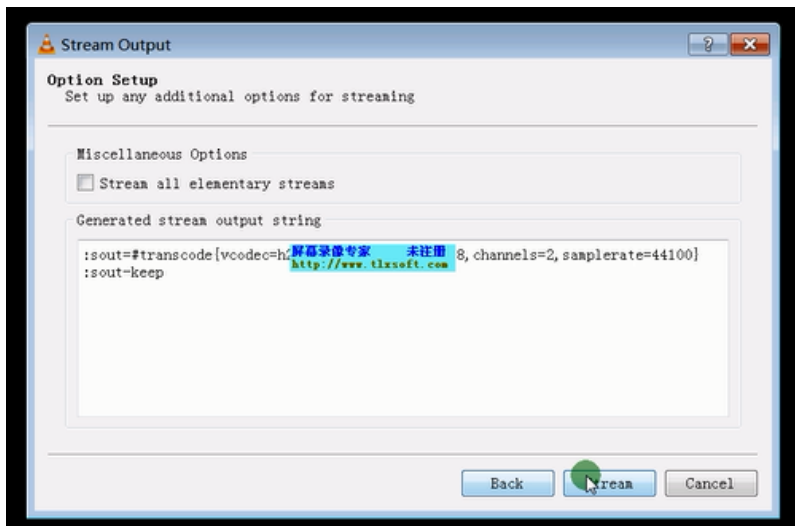

Step 10: Click “Open Network Stream”, then you can click “Play” to view the video.

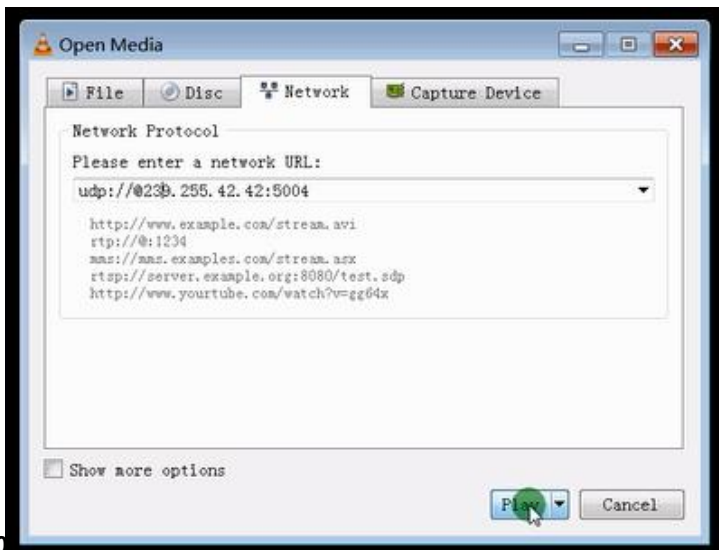
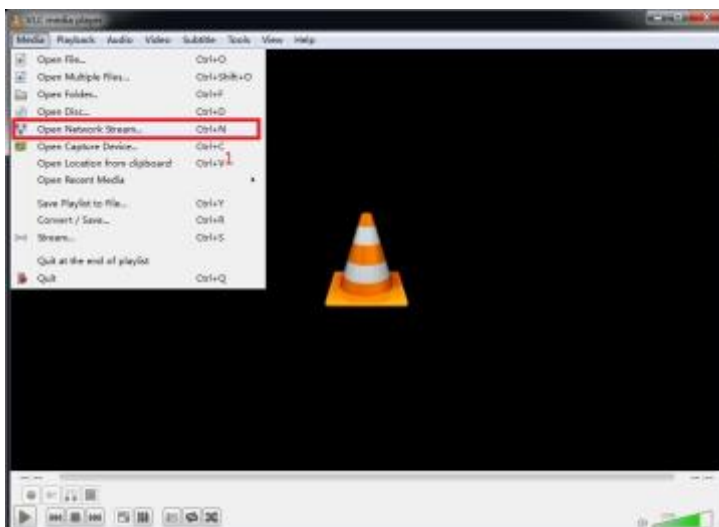

10

KanexPro™ warrants that (a) its products (the "Product") will perform greatly in agreement with the accompanying written materials for a period of 36 months (3 full years) from the date of receipt and (b) that the product will be free from defects in materials and workmanship under normal use and service for a period of 3 years.

B. CUSTOMER REMEDIES

KanexPro's entire liability and Customer's exclusive remedy shall be, at KanexPro option, either return of the price paid for the product, or repair or replacement of the Product that does not meet this Limited Warranty and which is returned to KanexPro with a copy of customers' receipt. This Limited Warranty is void if failure of the Product has resulted from accident, abuse, or misapplication. Any replacement Product will be warranted for the remainder of the original warranty period of 3 years, whichever is longer.

C. NO OTHER WARRANTIES

To the maximum extent permitted by applicable law, KanexPro disclaims all other warranties, either express or implied, including, but not limited to implied warranties of merchantability and fitness for a particular purpose, with regard to the product and any related written materials. This limited warranty gives customers specific legal rights. Customers may have other rights depending on the jurisdiction.

D. NO LIABILITY FOR DAMAGES

To the maximum extent permitted by applicable law, in no event shall KanexPro be liable for any damages whatsoever (including without limitation, special, incidental, consequential, or indirect damages for personal injury, loss of business profits, business interruption, loss of business information, or

KANEXPRO

EXT-AVIPH264TX

any other pecuniary loss) arising out of the use of or inability to use this product, even if KanexPro has been advised of the possibility of such damages.

KanexPro

1405 Pioneer
Street
Brea, CA 92821